

UNIT IV
TRANSPORT LAYER

Transport layer - Services - Berkeley Sockets -Example – Elements of Transport protocols – Addressing - Connection Establishment - Connection Release - Flow Control and Buffering – Multiplexing – Congestion Control - Bandwidth Allocation - Regulating the Sending Rate –UDP- RPC – TCP - TCP Segment Header - Connection Establishment - Connection Release - TCP Congestion Control

Introduction:

The network layer provides end-to-end packet delivery using data-grams or virtual circuits. The transport layer builds on the network layer to provide data transport from a process on a source machine to a process on a destination machine with a desired level of reliability that is independent of the physical networks currently in use. It provides the abstractions that applications need to use the network.

Transport Entity: The hardware and/or software which make use of services provided by the network layer, (within the transport layer) is called transport entity.

Transport Service Provider: Layers 1 to 4 are called Transport Service Provider.

Transport Service User: The upper layers i.e., layers 5 to 7 are called Transport Service User.

Transport Service Primitives: Which allow transport users (application programs) to access the transport service.

TPDU (Transport Protocol Data Unit): Transmissions of message between 2 transport entities are carried out by TPDU. The transport entity carries out the transport service primitives by blocking the caller and sending a packet the service. Encapsulated in the payload of this packet is a transport layer message for the server's transport entity. The task of the transport layer is to provide reliable, cost-effective data transport from the source machine to the destination machine, independent of physical network or networks currently in use.

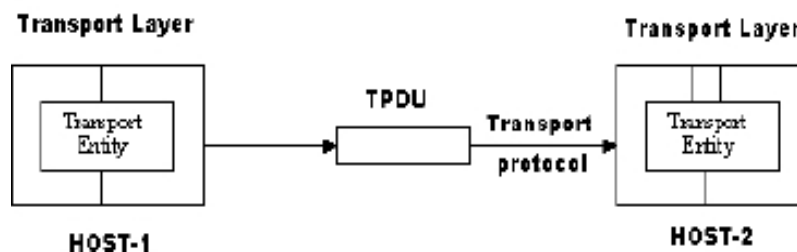

TRANSPORT SERVICE

1. Services Provided to the Upper Layers

The ultimate goal of the transport layer is to provide efficient, **reliable, and cost-effective data transmission** service to its users, normally processes in the application layer. To achieve this, the transport layer makes use of the **services pro-vided by the network layer**. The software and/or hardware within the transport layer that does the work is called the **transport entity**. The transport entity can be located in the operating system kernel, in a library package bound into network applications, in a separate user process, or even on the network interface card.

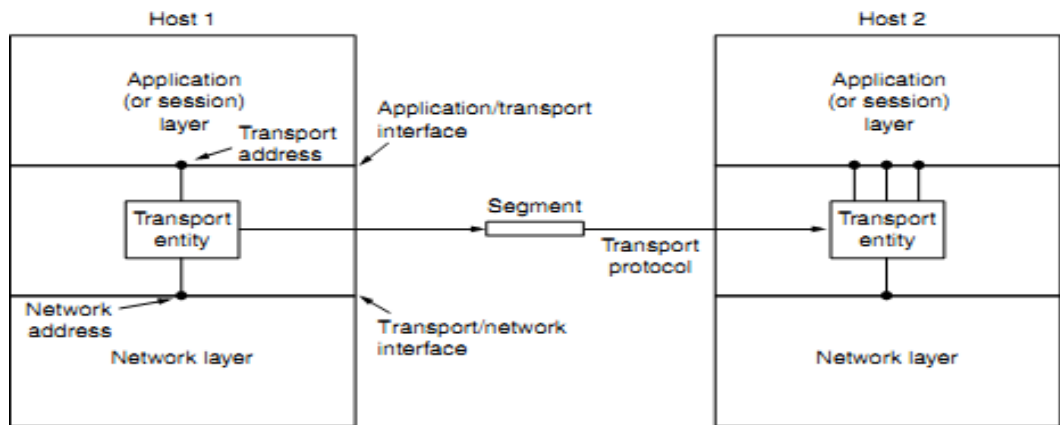

Fig 4.1: The network, Application and transport layer

There are two types of network service

- Connection-oriented
- Connectionless

Similarly, there are also two types of transport service. The connection-oriented transport service is similar to the connection-oriented network service in many ways.

In both cases, connections have three phases:

- Establishment
- Data transfer
- Release.
- Addressing and flow control are also similar in both layers. Furthermore, the connectionless transport service is also very similar to the connectionless network service.
- The bottom four layers can be seen as the transport service provider, whereas the upper layer(s) are the transport service user.

2. Transport Service Primitives

- To allow users to access the transport service, the transport layer must provide some operations to application programs, that is, a transport service interface. Each transport service has its own interface.
- The transport service is similar to the network service, but there are also some important differences.
- The **main difference** is that the network service is intended to model the service offered by real networks. Real networks can lose packets, so the network service is generally **unreliable**.
- The (connection-oriented) transport service, in contrast, is **reliable**

As an example, consider two processes connected by pipes in UNIX. They assume the connection between them is perfect. They do not want to know about acknowledgements, lost packets, congestion, or anything like that. What they want is a 100 percent reliable connection. Process A puts data into one end of the pipe, and process B takes it out of the other.

A **second difference** between the network service and transport service is **whom the services are intended for**. The network service is used only by the transport entities. Consequently, the transport service must be convenient and easy to use.

Table:4.1 - The primitives for a simple transport service.

Primitive	Packet sent	Meaning
LISTEN	(none)	Block until some process tries to connect
CONNECT	CONNECTION REQ.	Actively attempt to establish a connection
SEND	DATA	Send information
RECEIVE	(none)	Block until a DATA packet arrives
DISCONNECT	DISCONNECTION REQ.	This side wants to release the connection

Eg: Consider an application with a server and a number of remote clients.

1. The server executes a “LISTEN” primitive by calling a library procedure that makes a System call to block the server until a client turns up.
2. When a client wants to talk to the server, it executes a “CONNECT” primitive, with “CONNECTION REQUEST” TPDU sent to the server.
3. When it arrives, the TE unblocks the server and sends a “CONNECTION ACCEPTED” TPDU back to the client.
4. When it arrives, the client is unblocked and the connection is established. Data can now be exchanged using “SEND” and “RECEIVE” primitives.
5. When a connection is no longer needed, it must be released to free up table space within the 2 transport entries, which is done with “DISCONNECT” primitive by sending “DISCONNECTION REQUEST”

TPDU. This disconnection can be done either by asymmetric variant (connection is released, depending on other one) or by symmetric variant (connection is released, independent of other one).

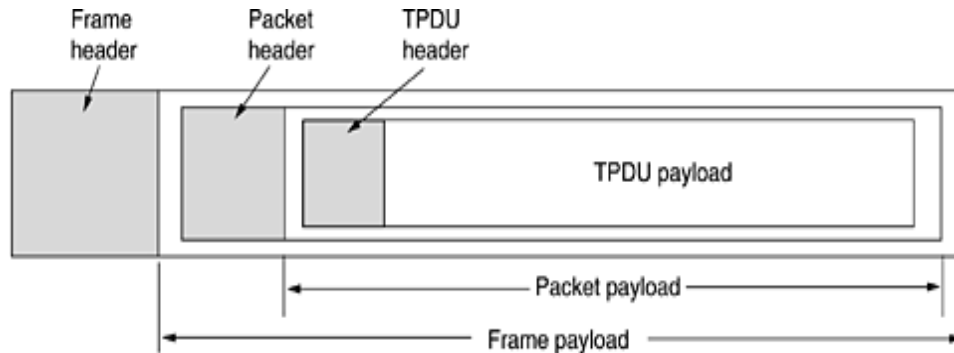

Figure 4.2 - Nesting of TPDU, packets, and frames

- The term segment for messages sent from transport entity to transport entity.
- TCP, UDP and other Internet protocols use this term. Segments (exchanged by the transport layer) are contained in packets (exchanged by the network layer).
- These packets are contained in frames (exchanged by the data link layer). When a frame arrives, the data link layer processes the frame header and, if the destination address matches for local delivery, passes the contents of the frame payload field up to the network entity.
- The network entity similarly processes the packet header and then passes the contents of the packet payload up to the transport entity. This nesting is illustrated in Fig. 4.2.

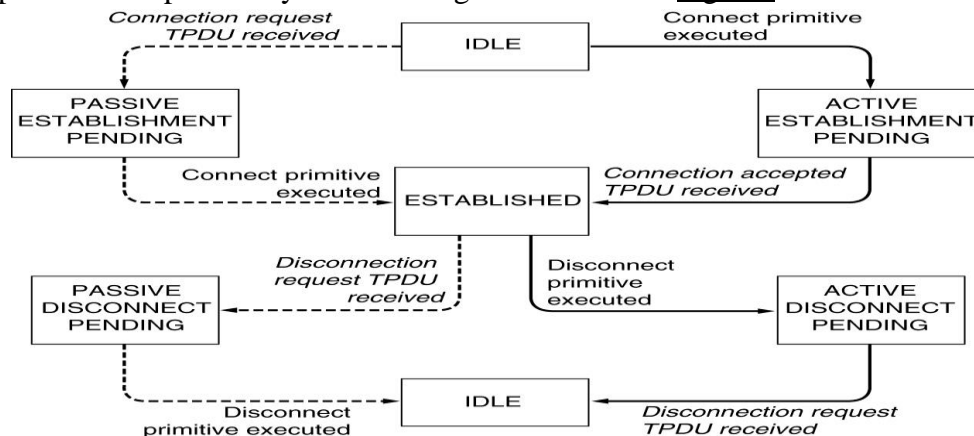

Figure 4.3 - A state diagram for a simple connection management scheme. Transitions labelled in italics are caused by packet arrivals. The solid lines show the client's state sequence. The dashed lines show the server's state sequence.

In fig. 4.3 each transition is triggered by some event, either a primitive executed by the local transport user or an incoming packet. For simplicity, we assume here that each TPDU is separately acknowledged. We also assume that a symmetric disconnection model is used, with the client going first. Please note that this model is quite unsophisticated. We will look at more realistic models later on.

BERKLEY SOCKETS

These primitives are socket primitives used in Berkley UNIX for TCP.

The socket primitives are mainly used for TCP. These sockets were first released as part of the Berkeley UNIX 4.2BSD software distribution in 1983. They quickly became popular. The primitives are now widely used for Internet programming on many operating systems, especially UNIX -based systems, and there is a socket-style API for Windows called “**winsock.**”

Primitive	Meaning
SOCKET	Create a new communication end point
BIND	Attach a local address to a socket
LISTEN	Announce willingness to accept connections; give queue size
ACCEPT	Block the caller until a connection attempt arrives
CONNECT	Actively attempt to establish a connection
SEND	Send some data over the connection
RECEIVE	Receive some data from the connection
CLOSE	Release the connection

Figure 4.4 - The socket primitives for TCP.

The first four primitives in the list are executed in that order by servers.

The **SOCKET** primitive creates a new endpoint and allocates table space for it within the transport entity. The parameter includes the addressing format to be used, the type of service desired and the protocol. Newly created sockets do not have network addresses.

- The **BIND** primitive is used to connect the newly created sockets to an address. Once a server has bound an address to a socket, remote clients can connect to it.
- The **LISTEN** call, which allocates space to queue incoming calls for the case that several clients try to connect at the same time.
- The server executes an **ACCEPT** primitive to block waiting for an incoming connection.

Some of the client side primitives are. Here, too, a socket must first be created

- The **CONNECT** primitive blocks the caller and actively starts the connection process. When it completes, the client process is unblocked and the connection is established.
- Both sides can now use **SEND** and **RECEIVE** to transmit and receive data over the full-duplex connection.
- Connection release with sockets is symmetric. When both sides have executed a **CLOSE** primitive, the connection is released.

ELEMENTS OF TRANSPORT PROTOCOLS

The transport service is implemented by a transport protocol used between the two transport entities. The transport protocols resemble the data link protocols. Both have to deal with error control, sequencing, and flow control, among other issues. The difference transport protocol and data link protocol depends upon the environment in which they are operated.

These differences are due to major dissimilarities between the environments in which the two protocols operate, as shown in Fig.

At the data link layer, two routers communicate directly via a physical channel, whether wired or wireless, whereas at the transport layer, this physical channel is replaced by the entire network. This difference has many important implications for the protocols.

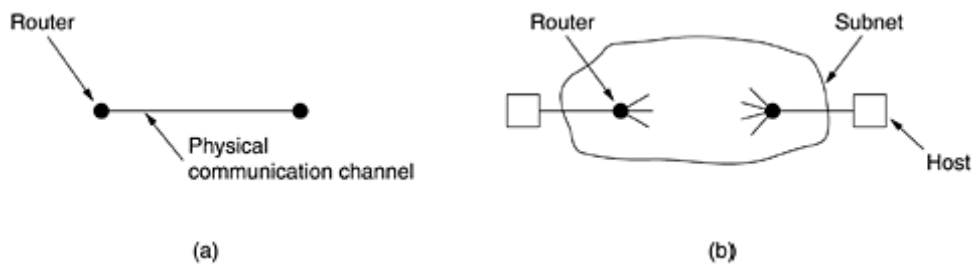

Figure (a) Environment of the data link layer. (b) Environment of the transport layer.

In the data link layer, it is not necessary for a router to specify which router it wants to talk to. In the transport layer, explicit addressing of destinations is required.

In the transport layer, initial connection establishment is more complicated, as we will see. Difference between the data link layer and the transport layer is the potential existence of storage capacity in the subnet

Buffering and flow control are needed in both layers, but the presence of a large and dynamically varying number of connections in the transport layer may require a different approach than we used in the data link layer.

The transport service is implemented by a transport protocol between the 2 transport entities.

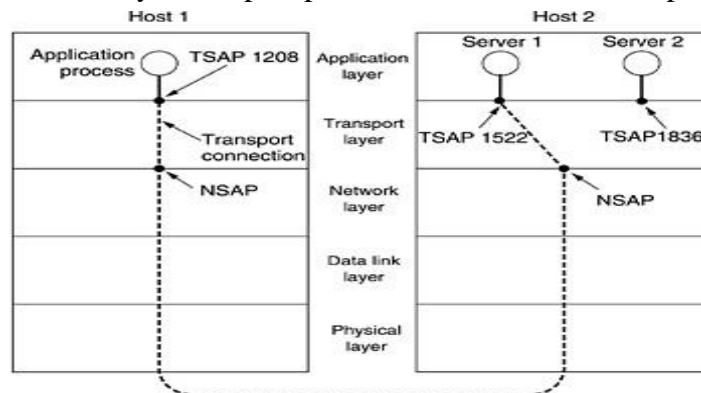

Figure 4.5 illustrates the relationship between the NSAP, TSAP and transport connection. Application processes, both clients and servers, can attach themselves to a TSAP to establish a connection to a remote TSAP.

These connections run through NSAPs on each host, as shown. The purpose of having TSAPs is that in some networks, each computer has a single NSAP, so some way is needed to distinguish multiple transport endpoints that share that NSAP.

The elements of transport protocols are:

1. ADDRESSING
2. Connection Establishment.
3. Connection Release.
4. Error control and flow control
5. Multiplexing.

1. ADDRESSING

When an application (e.g., a user) process wishes to set up a connection to a remote application process, it must specify which one to connect to. The method normally used is to define transport addresses to which processes can listen for connection requests. In the Internet, these endpoints are called **ports**.

There are two types of access points.

TSAP (Transport Service Access Point) to mean a specific endpoint in the transport layer.

The analogous endpoints in the network layer (i.e., network layer addresses) are not surprisingly called **NSAPs (Network Service Access Points)**. IP addresses are examples of NSAPs.

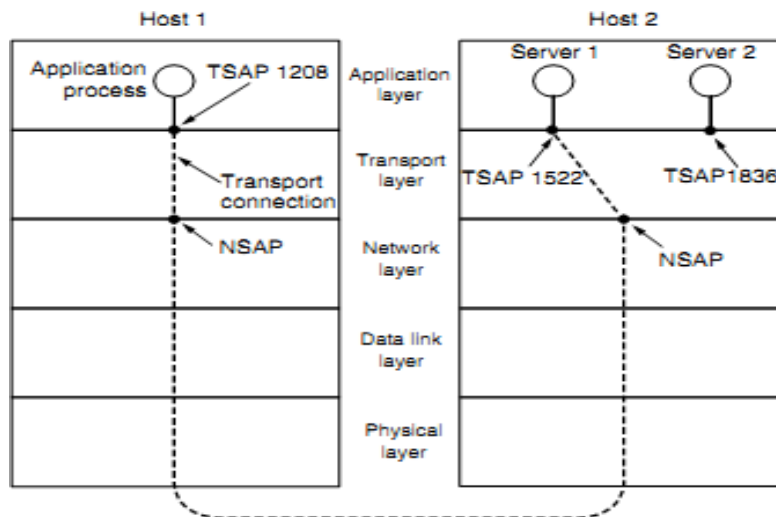

Fig 4.5: TSAP and NSAP network connections

Application processes, both clients and servers, can attach themselves to a local TSAP to establish a connection to a remote TSAP. These connections run through NSAPs on each host. The purpose of having TSAPs is that in some networks, each computer has a single NSAP, so some way is needed to distinguish multiple transport endpoints that share that NSAP.

A possible scenario for a transport connection is as follows:

1. A mail server process attaches itself to TSAP 1522 on host 2 to wait for an incoming call. How a process attaches itself to a TSAP is outside the networking model and depends entirely on the local operating system. A call such as our LISTEN might be used, for example.
2. An application process on host 1 wants to send an email message, so it attaches itself to TSAP 1208 and issues a CONNECT request. The request specifies TSAP 1208 on host 1 as the source and TSAP 1522 on host 2 as the destination. This action ultimately results in a transport connection being established between the application process and the server.
3. The application process sends over the mail message.
4. The mail server responds to say that it will deliver the message.
5. The transport connection is released.

2. CONNECTION ESTABLISHMENT:

With packet lifetimes bounded, it is possible to devise a fool proof way to establish connections safely. Packet lifetime can be bounded to a known maximum using one of the following techniques:

- Restricted subnet design
- Putting a hop counter in each packet
- Time stamping in each packet

Using a 3-way hand shake, a connection can be established. This establishment protocol doesn't require both sides to begin sending with the same sequence number.

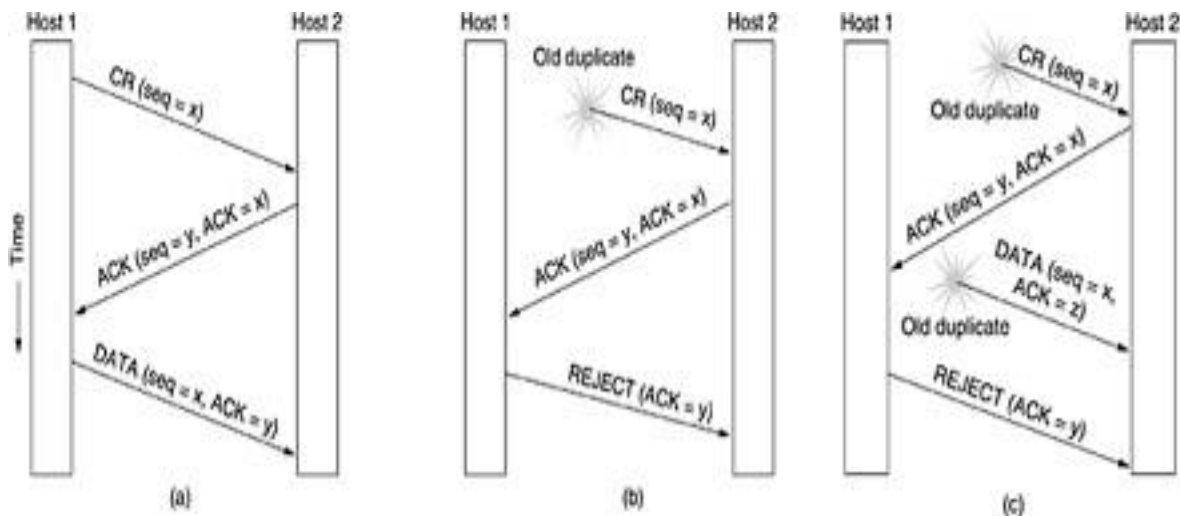

Fig 4.6: Three protocol scenarios for establishing a connection using a three-way handshake. CR denotes CONNECTION REQUEST (a) Normal operation. (b) Old duplicate CONNECTION REQUEST appearing out of nowhere. (c) Duplicate CONNECTION REQUEST and duplicate ACK.

- The **first technique** includes any method that prevents packets from looping, combined with some way of bounding delay including congestion over the longest possible path. It is difficult, given that internets may range from a single city to international in scope.
- The **second method** consists of having the hop count initialized to some appropriate value and decremented each time the packet is forwarded. The network protocol simply discards any packet whose hop counter becomes zero.
- The **third method** requires each packet to bear the time it was created, with the routers agreeing to discard any packet older than some agreed-upon time.

In **fig (A)** Tomlinson (1975) introduced the **three-way handshake**.

- This establishment protocol involves one peer checking with the other that the connection request is indeed current. Host 1 chooses a sequence number, x , and sends a CONNECTION REQUEST segment containing it to host 2. Host 2 replies with an ACK segment acknowledging x and announcing its own initial sequence number, y .
- Finally, host 1 acknowledges host 2's choice of an initial sequence number in the first data segment that it sends

In **fig (B)** the first segment is a delayed duplicate CONNECTION REQUEST from an old connection.

- This segment arrives at host 2 without host 1's knowledge. Host 2 reacts to this segment by sending host 1 an ACK segment, in effect asking for verification that host 1 was indeed trying to set up a new connection.
- When host 1 rejects host 2's attempt to establish a connection, host 2 realizes that it was tricked by a delayed duplicate and abandons the connection. In this way, a delayed duplicate does no damage.
- The worst case is when both a delayed CONNECTION REQUEST and an ACK are floating around in the subnet.

In **fig (C)** previous example, host 2 gets a delayed CONNECTION REQUEST and replies to it.

- At this point, it is crucial to realize that host 2 has proposed using y as the initial sequence number for host 2 to host 1 traffic, knowing full well that no segments containing sequence number y or acknowledgements to y are still in existence.
- When the second delayed segment arrives at host 2, the fact that z has been acknowledged rather than y tells host 2 that this, too, is an old duplicate.

- The important thing to realize here is that there is no combination of old segments that can cause the protocol to fail and have a connection set up by accident when no one wants it.

3.CONNECTION RELEASE:

A connection is released using either asymmetric or symmetric variant. But, the improved protocol for releasing a connection is a 3-way handshake protocol.

There are two styles of terminating a connection:

- 1) Asymmetric release and
- 2) Symmetric release.

Asymmetric release is the way the telephone system works: when one party hangs up, the connection is broken. **Symmetric release** treats the connection as two separate unidirectional connections and requires each one to be released separately.

Fig-(a)	Fig-(b)	Fig-(c)	Fig-(d)
<p>One of the user sends a DISCONNECTION REQUEST TPDU in order to initiate connection release. When it arrives, the recipient sends back a DR-TPDU, too, and starts a timer. When this DR arrives, the original sender sends back an ACK-TPDU and releases the connection. Finally, when the ACK-TPDU arrives, the receiver also releases the connection.</p>	<p>Initial process is done in the same way as in fig-(a). If the final ACK-TPDU is lost, the situation is saved by the timer. When the timer is expired, the connection is released.</p>	<p>If the second DR is lost, the user initiating the disconnection will not receive the expected response, and will timeout and starts all over again.</p>	<p>Same as in fig-(c) except that all repeated attempts to retransmit the DR is assumed to be failed due to lost TPDU's. After 'N' entries, the sender just gives up and releases the connection.</p>

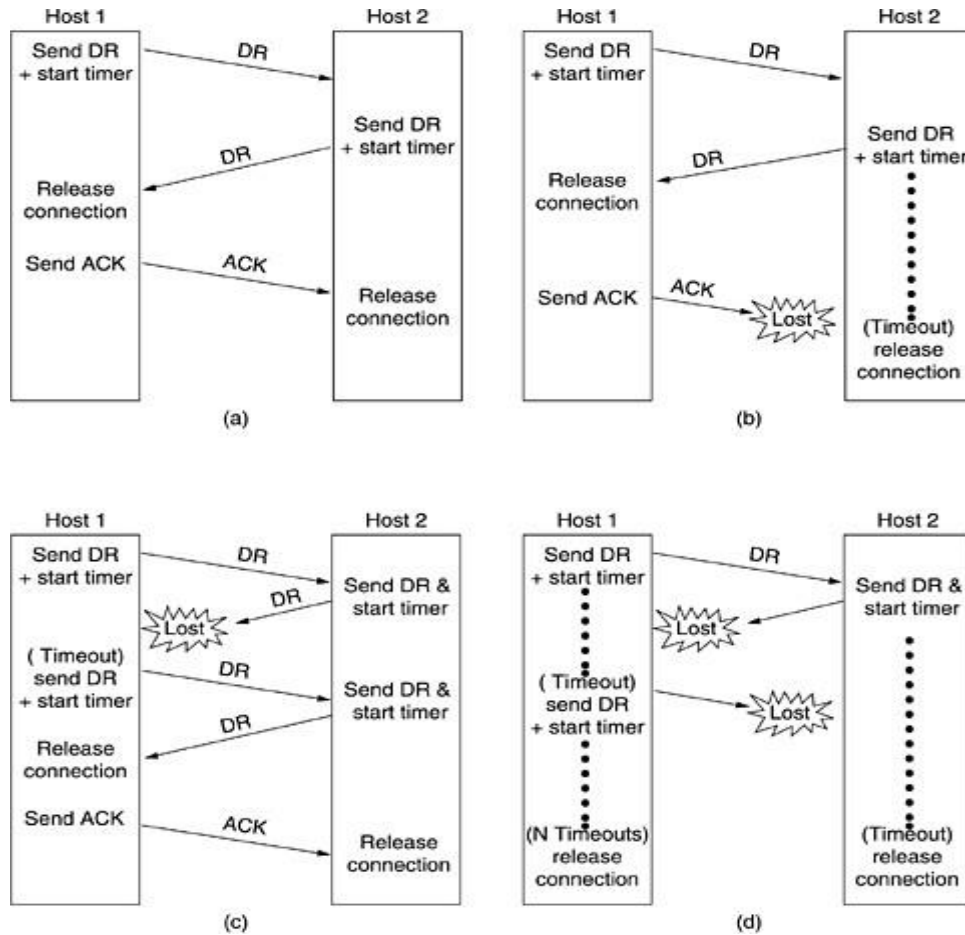

4.FLOW CONTROL AND BUFFERING:

Flow control is done by having a sliding window on each connection to keep a fast transmitter from over running a slow receiver. Buffering must be done by the sender, if the network service is unreliable. The sender buffers all the TPDU's sent to the receiver. The buffer size varies for different TPDU's.

They are:

- Chained Fixed-size Buffers
- Chained Variable-size Buffers
- One large Circular Buffer per Connection

(a). Chained Fixed-size Buffers:

If most TPDU's are nearly the same size, the buffers are organized as a pool of identical size buffers, with one TPDU per buffer.

(b). Chained Variable-size Buffers:

This is an approach to the buffer-size problem. i.e., if there is wide variation in TPDU size, from a few characters typed at a terminal to thousands of characters from file transfers, some problems may occur:

- If the buffer size is chosen equal to the largest possible TPDU, space will be wasted whenever a short TPDU arrives.
- If the buffer size is chosen less than the maximum TPDU size, multiple buffers will be needed for long TPDU.

To overcome these problems, we employ variable-size buffers.

(c). One large Circular Buffer per Connection:

A single large circular buffer per connection is dedicated when all connections are heavily loaded.

1. Source Buffering is used for low band width bursty traffic
2. Destination Buffering is used for high band width smooth traffic.
3. Dynamic Buffering is used if the traffic pattern changes randomly.

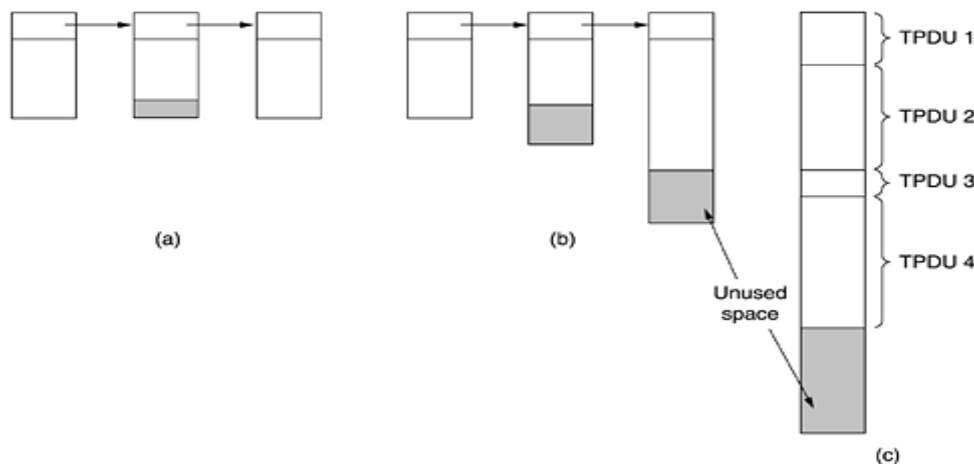

Figure 4.7. (a) Chained fixed-size buffers. (b) Chained variable-sized buffers. (c) One large circular buffer per connection.

5.MULTIPLEXING:

In networks that use virtual circuits within the subnet, each open connection consumes some table space in the routers for the entire duration of the connection. If buffers are dedicated to the virtual circuit in each router as well, a user who left a terminal logged into a remote machine, there is need for multiplexing. There are 2 kinds of multiplexing:

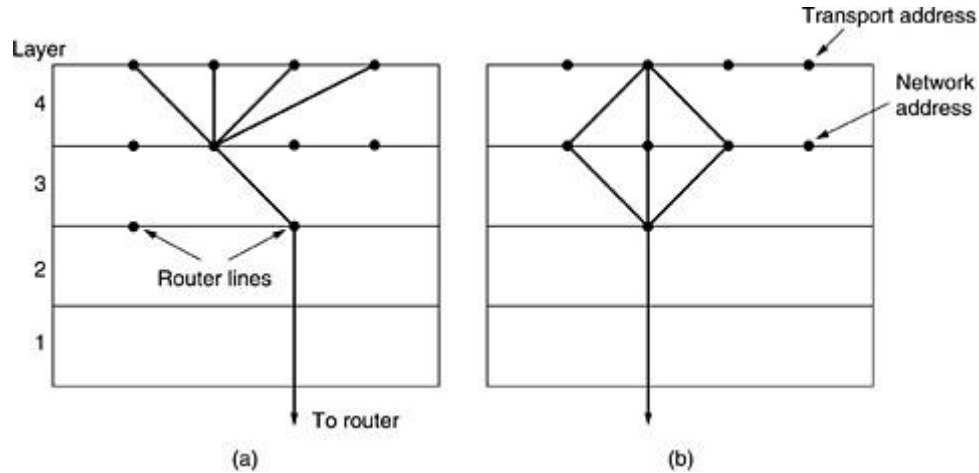

Figure 4.8. (a) Upward multiplexing. (b) Downward multiplexing

(a). **UP-WARD MULTIPLEXING:**

In the below figure, all the 4 distinct transport connections use the same network connection to the remote host. When connect time forms the major component of the carrier's bill, it is up to the transport layer to group port connections according to their destination and map each group onto the minimum number of port connections.

(b). **DOWN-WARD MULTIPLEXING:**

- If too many transport connections are mapped onto the one network connection, the performance will be poor.
- If too few transport connections are mapped onto one network connection, the service will be expensive.

The possible solution is to have the transport layer open multiple connections and distribute the traffic among them on round-robin basis, as indicated in the below figure:

With 'k' network connections open, the effective band width is increased by a factor of 'k'.

TRANSPORT PROTOCOLS - UDP

The Internet has two main protocols in the transport layer, a **connectionless protocol** and a **connection-oriented** one. The protocols complement each other. The connectionless protocol is **UDP**. It does almost nothing beyond sending packets between applications, letting applications build their own protocols on top as needed.

The connection-oriented protocol is **TCP**. It does almost everything. It makes connections and adds reliability with retransmissions, along with flow control and congestion control, all on behalf of the

applications that use it. Since UDP is a transport layer protocol that typically runs in the operating system and protocols that use UDP typically run in user space, these uses might be considered applications.

INTRODUCTION TO UDP

- The Internet protocol suite supports a connectionless transport protocol called UDP (User Datagram Protocol). UDP provides a way for applications to send encapsulated IP datagrams without having to establish a connection.
- UDP transmits segments consisting of an 8-byte header followed by the pay-load. The two ports serve to identify the end-points within the source and destination machines.
- When a UDP packet arrives, its payload is handed to the process attached to the destination port. This attachment occurs when the BIND primitive. Without the port fields, the transport layer would not know what to do with each incoming packet. With them, it delivers the embedded segment to the correct application.

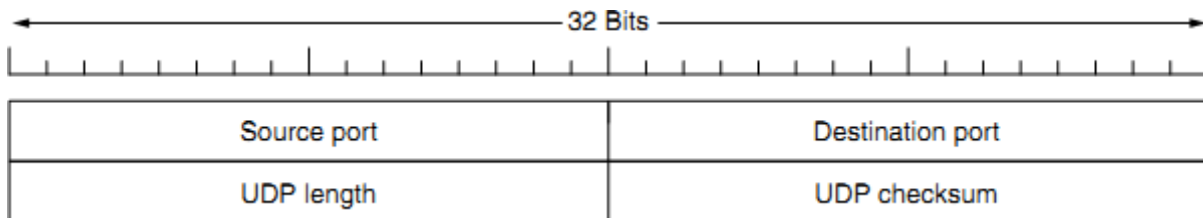

Fig 4.9: The UDP header

Source port, destination port: Identifies the end points within the source and destination machines.

UDP length: Includes 8-byte header and the data

UDP checksum: Includes the UDP header, the UDP data padded out to an even number of bytes if need be. It is an optional field

REMOTE PROCEDURE CALL

- In a certain sense, sending a message to a remote host and getting a reply back is like making a function call in a programming language. This is to arrange request-reply interactions on networks to be cast in the form of procedure calls.
- For example, just imagine a procedure named *get IP address (host name)* that works by sending a UDP packet to a DNS server and waiting for the reply, timing out and trying again if one is not forthcoming quickly enough. In this way, all the details of networking can be hidden from the programmer.
- RPC is used to call remote programs using the procedural call. When a process on machine 1 calls a procedure on machine 2, the calling process on 1 is suspended and execution of the called procedure takes place on 2.
- Information can be transported from the caller to the callee in the parameters and can come back in the procedure result. No message passing is visible to the application programmer. This technique is known as **RPC (Remote Procedure Call)** and has become the basis for many networking applications.

Traditionally, the calling procedure is known as the **client** and the called procedure is known as the **server**.

- In the simplest form, to call a remote procedure, the client program must be bound with a small library procedure, called the **client stub**, that represents the server procedure in the client's address space. Similarly, the server is bound with a procedure called the **server stub**. These procedures hide the fact that the procedure call from the client to the server is not local.

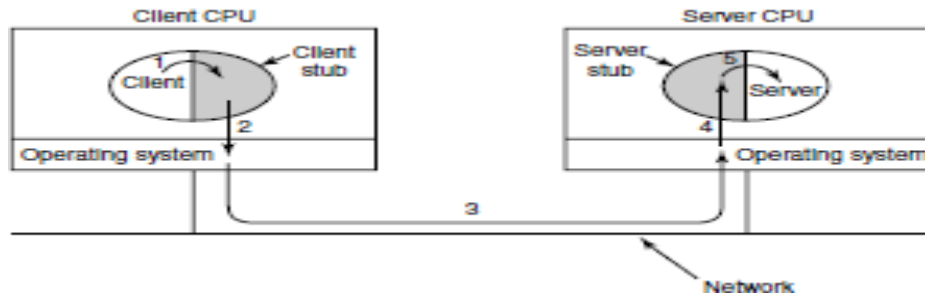

Fig 4.10: Steps in making a RPC

Step 1 is the client calling the client stub. This call is a local procedure call, with the parameters pushed onto the stack in the normal way.

Step 2 is the client stub packing the parameters into a message and making a system call to send the message. Packing the parameters is called **marshaling**.

Step 3 is the operating system sending the message from the client machine to the server machine.

Step 4 is the operating system passing the incoming packet to the server stub.

Step 5 is the server stub calling the server procedure with the **unmarshaled** parameters. The reply traces the same path in the other direction.

The key item to note here is that the client procedure, written by the user, just makes a normal (i.e., local) procedure call to the client stub, which has the same name as the server procedure. Since the client procedure and client stub are in the same address space, the parameters are passed in the usual way.

Similarly, the server procedure is called by a procedure in its address space with the parameters it expects. To the server procedure, nothing is unusual. In this way, instead of I/O being done on sockets, network communication is done by faking a normal procedure call. With RPC, passing pointers is impossible because the client and server are in different address spaces.

TCP (TRANSMISSION CONTROL PROTOCOL)

It was specifically designed to provide a reliable end-to end byte stream over an unreliable network. It was designed to adapt dynamically to properties of the inter network and to be robust in the face of many kinds of failures.

Each machine supporting TCP has a TCP transport entity, which accepts user data streams from local processes, breaks them up into pieces not exceeding 64kbytes and sends each piece as a separate IP datagram. When these datagrams arrive at a machine, they are given to TCP entity, which reconstructs the original byte streams. It is up to TCP to time out and retransmits them as needed, also to reassemble datagrams into messages in proper sequence.

The different issues to be considered are:

1. The TCP Service Model
2. The TCP Protocol
3. The TCP Segment Header
4. The Connection Management
5. TCP Transmission Policy
6. TCP Congestion Control
7. TCP Timer Management.

The TCP Service Model

- TCP service is obtained by having both the sender and receiver create end points called **SOCKETS**
- Each socket has a socket number(address)consisting of the IP address of the host, called a “**PORT**” (= TSAP)
- To obtain TCP service a connection must be explicitly established between a socket on the sending machine and a socket on the receiving machine
- All TCP connections are full duplex and point to point i.e., multicasting or broadcasting is not supported.
- A TCP connection is a byte stream, not a message stream i.e., the data is delivered as chunks

*E.g.: 4 * 512 bytes of data is to be transmitted.*

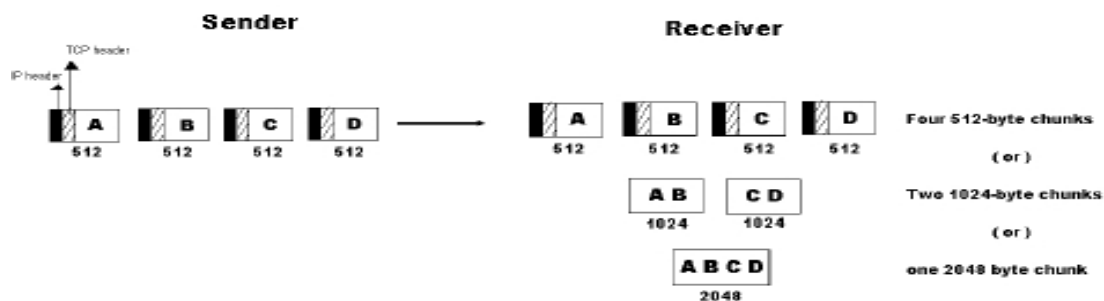

Sockets:

A socket may be used for multiple connections at the same time. In other words, 2 or more connections may terminate at same socket. Connections are identified by socket identifiers at same socket. Connections are identified by socket identifiers at both ends. Some of the sockets are listed below:

Primitive	Meaning
SOCKET	Create a new communication end point
BIND	Attach a local address to a socket
LISTEN	Announce willingness to accept connections; give queue size
ACCEPT	Block the caller until a connection attempt arrives
CONNECT	Actively attempt to establish a connection
SEND	Send some data over the connection
RECEIVE	Receive some data from the connection
CLOSE	Release the connection

Ports: Port numbers below 256 are called Well- known ports and are reserved for standard services.

Eg:

PORT-21	To establish a connection to a host to transfer a file using FTP
PORT-23	To establish a remote login session using TELNET

The TCP Protocol

- A key feature of TCP, and one which dominates the protocol design, is that every byte on a TCP connection has its own 32-bit sequence number.
- When the Internet began, the lines between routers were mostly 56-kbps leased lines, so a host blasting away at full speed took over 1 week to cycle through the sequence numbers.
- The basic protocol used by TCP entities is the **sliding window protocol**.
- When a sender transmits a segment, it also starts a timer.
- When the segment arrives at the destination, the receiving TCP entity sends back a segment (with data if any exist, otherwise without data) bearing an acknowledgement number equal to the next sequence number it expects to receive.
- If the sender's timer goes off before the acknowledgement is received, the sender transmits the segment again.

The TCP Segment Header

Every segment begins with a fixed-format, 20-byte header. The fixed header may be followed by header options. After the options, if any, up to $65,535 - 20 - 20 = 65,495$ data bytes may follow, where the first 20 refer to the IP header and the second to the TCP header. Segments without any data are legal and are commonly used for acknowledgements and control messages.

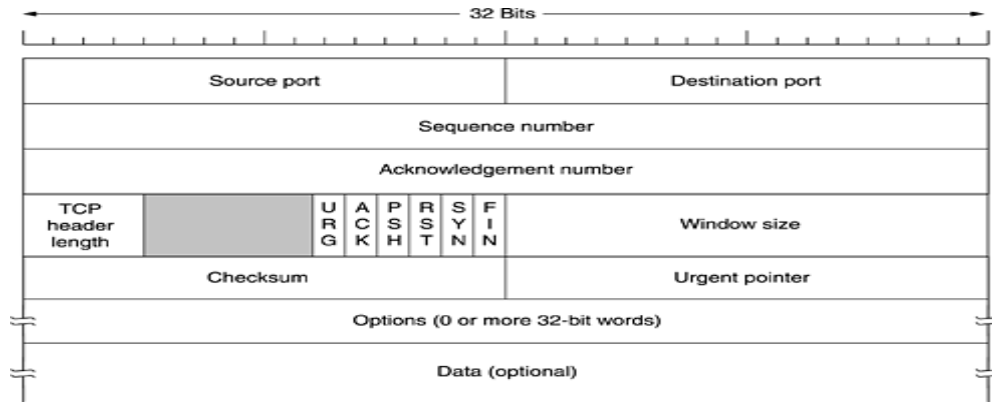

Fig 4.11: The TCP Header

Source Port, Destination Port : Identify local end points of the connections

Sequence number: Specifies the sequence number of the segment

Acknowledgement Number: Specifies the next byte expected.

TCP header length: Tells how many 32-bit words are contained in TCP header

URG: It is set to 1 if URGENT pointer is in use, which indicates start of urgent data.

ACK: It is set to 1 to indicate that the acknowledgement number is valid.

PSH: Indicates pushed data

RST: It is used to reset a connection that has become confused due to reject an invalid segment or refuse an attempt to open a connection.

FIN: Used to release a connection.

SYN: Used to establish connections.

TCP Connection Establishment

To establish a connection, one side, say, the server, passively waits for an incoming connection by executing the LISTEN and ACCEPT primitives, either specifying a specific source or nobody in particular.

The other side, say, the client, executes a CONNECT primitive, specifying the IP address and port to which it wants to connect, the maximum TCP segment size it is willing to accept, and optionally some user data (e.g., a password).

The CONNECT primitive sends a TCP segment with the SYN bit on and ACK bit off and waits for a response.

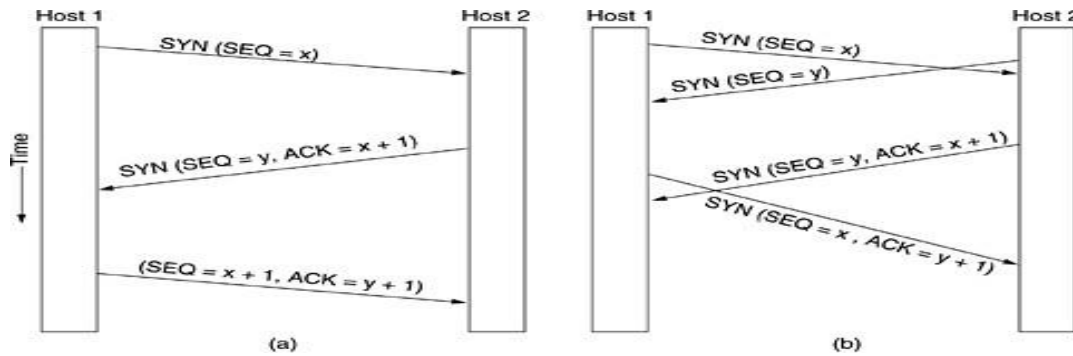

Fig 4.12: a) TCP Connection establishment in the normal case b) Call Collision

TCP Connection Release

- Although TCP connections are full duplex, to understand how connections are released it is best to think of them as a pair of simplex connections.
- Each simplex connection is released independently of its sibling. To release a connection, either party can send a TCP segment with the *FIN* bit set, which means that it has no more data to transmit.
- When the *FIN* is acknowledged, that direction is shut down for new data. Data may continue to flow indefinitely in the other direction, however.
- When both directions have been shut down, the connection is released.
- Normally, four TCP segments are needed to release a connection, one *FIN* and one *ACK* for each direction. However, it is possible for the first *ACK* and the second *FIN* to be contained in the same segment, reducing the total count to three.

TCP Connection Management Modeling

The steps required establishing and release connections can be represented in a finite state machine with the 11 states listed in Fig. 4.13. In each state, certain events are legal. When a legal event happens, some action may be taken. If some other event happens, an error is reported.

State	Description
CLOSED	No connection is active or pending
LISTEN	The server is waiting for an incoming call
SYN RCVD	A connection request has arrived; wait for ACK
SYN SENT	The application has started to open a connection
ESTABLISHED	The normal data transfer state
FIN WAIT 1	The application has said it is finished
FIN WAIT 2	The other side has agreed to release
TIMED WAIT	Wait for all packets to die off
CLOSING	Both sides have tried to close simultaneously
CLOSE WAIT	The other side has initiated a release
LAST ACK	Wait for all packets to die off

Figure 4.13. The states used in the TCP connection management finite state machine.

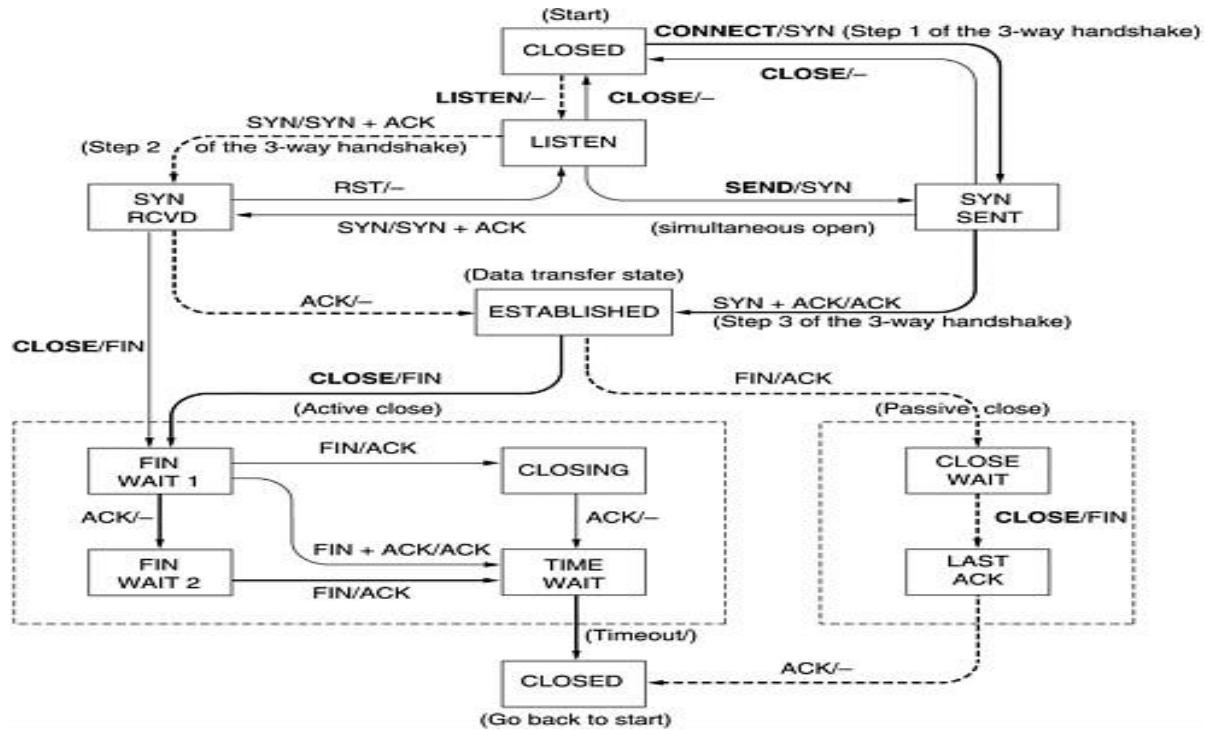

Figure 4.14 - TCP connection management finite state machine.

TCP Connection management from server's point of view:

1. The server does a **LISTEN** and settles down to see who turns up.
2. When a **SYN** comes in, the server acknowledges it and goes to the **SYNRCVD** state
3. When the servers **SYN** is itself acknowledged the 3-way handshake is complete and server goes to the **ESTABLISHED** state. Data transfer can now occur.
4. When the client has had enough, it does a close, which causes a **FIN** to arrive at the server [dashed box marked passive close].
5. The server is then signaled.
6. When it too, does a **CLOSE**, a **FIN** is sent to the client.
7. When the client's acknowledgement shows up, the server releases the connection and deletes the connection record.

TCP CONGESTION CONTROL:

TCP does to try to prevent the congestion from occurring in the first place in the following way:

When a connection is established, a suitable window size is chosen and the receiver specifies a window based on its buffer size. If the sender sticks to this window size, problems will not occur due to buffer overflow at the receiving end. But they may still occur due to internal congestion within the network. Let's see this problem occurs.

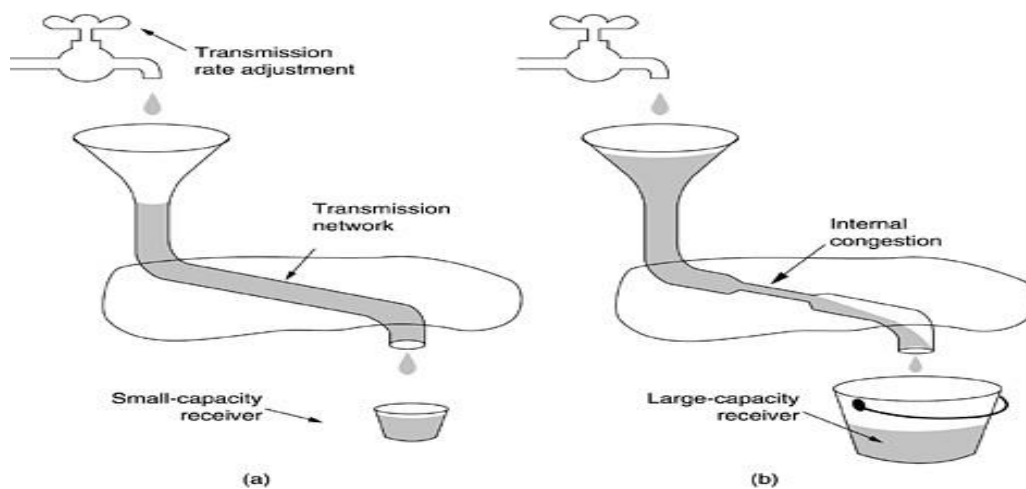

Figure 4.16. (a) A fast network feeding a low-capacity receiver. (b) A slow network feeding a high-capacity receiver.

In fig (a): We see a thick pipe leading to a small- capacity receiver. As long as the sender does not send more water than the bucket can contain, no water will be lost.

In fig (b): The limiting factor is not the bucket capacity, but the internal carrying capacity of the n/w. if too much water comes in too fast, it will backup and some will be lost.

- When a connection is established, the sender initializes the congestion window to the size of the max segment in use our connection.
- It then sends one max segment .if this max segment is acknowledged before the timer goes off, it adds one segment s worth of bytes to the congestion window to make it two maximum size segments and sends 2 segments.
- As each of these segments is acknowledged, the congestion window is increased by one max segment size.
- When the congestion window is ‘n’ segments, if all ‘n’ are acknowledged on time, the congestion window is increased by the byte count corresponding to ‘n’ segments.
- The congestion window keeps growing exponentially until either a time out occurs or the receiver’s window is reached.
- The internet congestion control algorithm uses a third parameter, the “**threshold**” in addition to receiver and congestion windows.

Different congestion control algorithms used by TCP are:

- RTT variance Estimation.
- Exponential RTO back-off Re-transmission Timer Management
- Karn’s Algorithm
- Slow Start
- Dynamic window sizing on congestion
- Fast Retransmit Window Management
- Fast Recovery

}

}